

## Nautilus 2000 Gallon Per Day Modular Desalination System

[www.makeh2o.com](http://www.makeh2o.com)

For a limited time, we are offering our “Nautilus” series system at factory direct savings, this special is available only through our website.

Our Nautilus 2000 is a complete watermaker system, with boost pump, fresh water flush, control panel, prefiltration, high pressure pump, and membrane/pressure vessel array, and all 316 stainless steel components!

Higher output, best quality, lowest price.

Check our standard features and you will find this system is now priced significantly less than any other watermaker on the market.

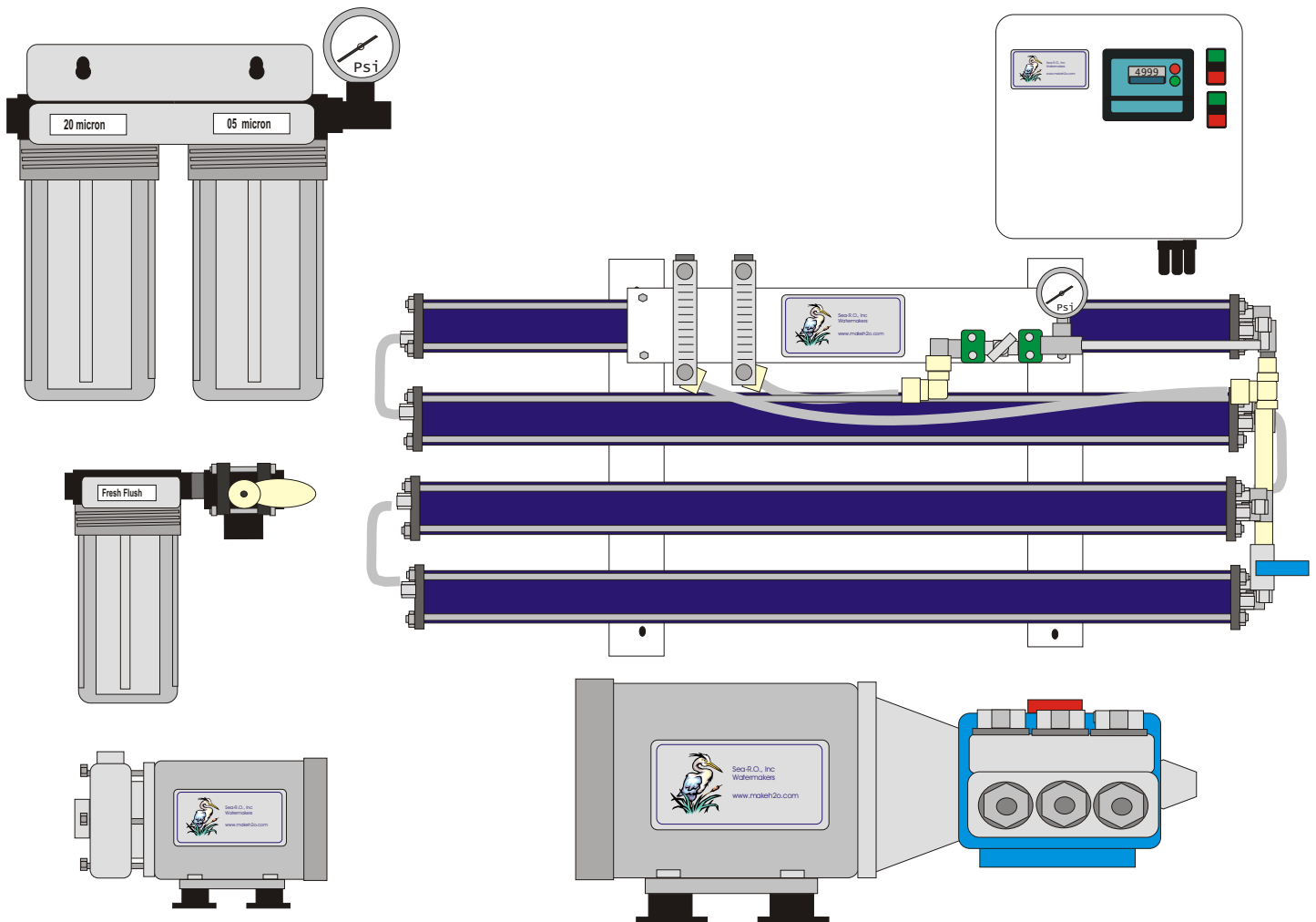

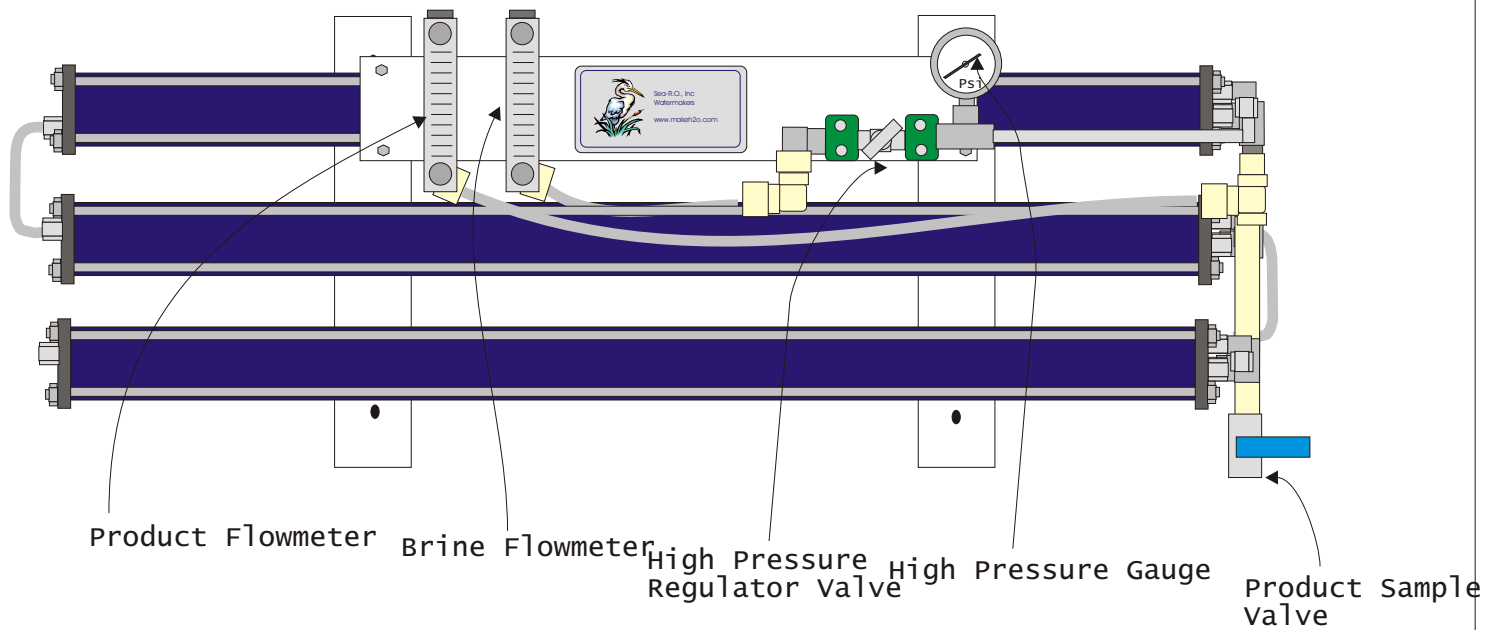

## “Nautilus” 2000 Membrane And Pressure vessel assembly

Pressure vessel is all fiberglass construction, 1000 psi rated. Simplified end cap design is rugged and easy to service with no special tools required, pressure and product ports are 316 SS with o-ring seals that allow fittings to swivel and eliminate stress on end cap material. Industry standard membrane size is available worldwide.

Mounting brackets are predrilled and allow easy attachment to bulkhead or wall, overhead mounting is possible with additional “L” brackets

Product flowmeter reads .1 to 1 gpm, stainless steel float and removable top cap for easy disassembly and cleaning. Outlet of flowmeter has dual attachment of either 1/4” FNPT or 1/2” MNPT for easy plumbing to storage tank.

Brine flowmeter has same features as above product flowmeter, with 0-5 gpm range. Plumb directly overboard or to a drain.

High pressure regulator valve is all 316 SS and is securely mounted to panel. Tee type handle allows precise pressure adjustment with no tools.

High pressure gauge has all 316 SS internals and is glycerine filled to provide accurate and steady pressure reading.

High pressure piping is 316 SS with positive sealing nut and ferrule connections.

Low pressure piping is flexible nylon tubing with nut and o-ring connections for leak free operation.

Simple Product Water Sample valve is included to allow easy sampling of product water before sending to storage tank. This also is a handy method of filling a container for supply of chilled drinking water in your refrigerator that is directly from the membrane.

High pressure hose connects to pump with industry standard 316 SS flare fittings with reusable type ends, allowing field replacement of hose with common tools and no swaging.

## Dual prefiltration system

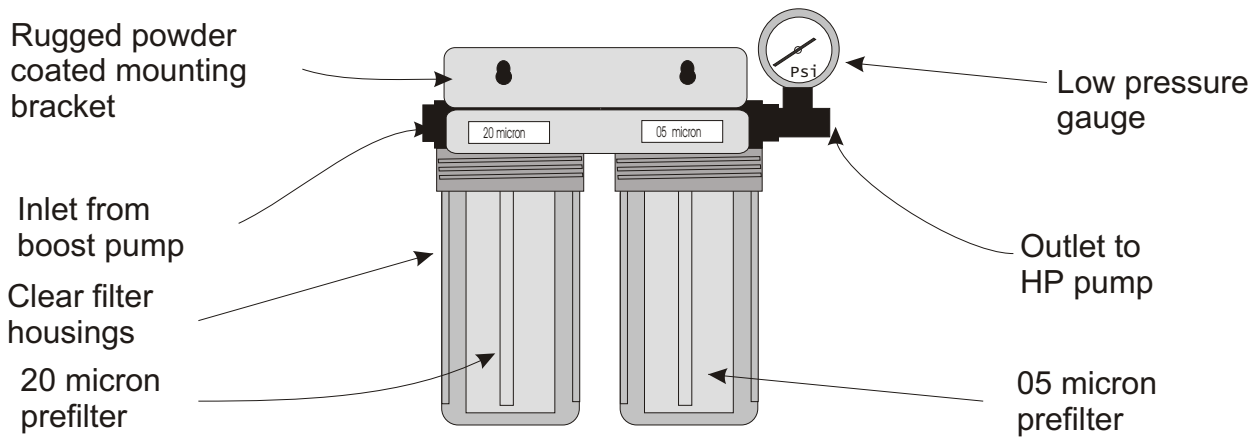

Clear FDA approved polypropylene housings are heavy duty industrial rated at 125 psi. O-ring sealed to provide leak free operation. Standard 1" FNPT inlet and outlet.

Heavy Duty mounting bracket allows easy mounting. Six filter cartridges and filter housing wrench are included with system.(3 each 20 micron, and 3 each 05 micron)

Low pressure gauge monitors filter performance and indicates when service is required. 316SS and glycerine filled.

Dual 20 and 05 micron, 15 square foot filter cartridges provide optimum sediment and particle removal. 100% poly media permits cleaning several times before replacement. Industry standard "BB" 5x10" size.

## Auto Fresh water flush system

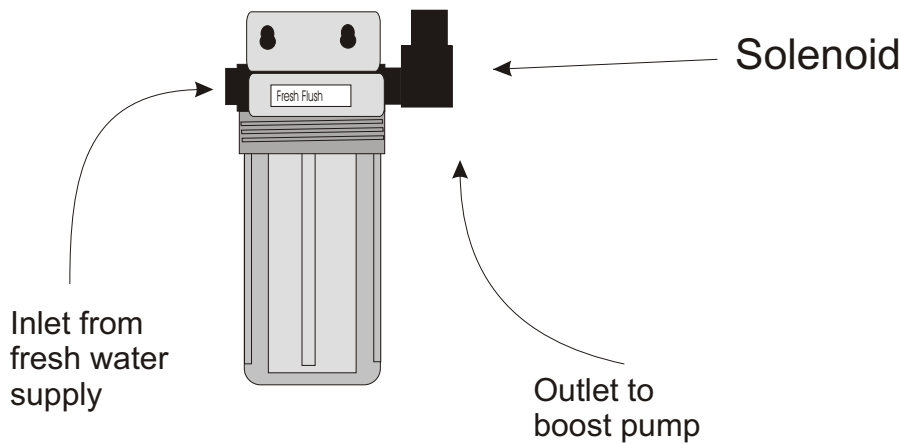

Auto Flush option flushes system on every shut down with de-chlorinated fresh water to purge sea water from system and greatly extend membrane performance.

Clear FDA approved polypropylene housing is heavy duty industrial rated at 125 psi. O-ring sealed to provide leak free operation, standard 3/4" FNPT inlet and outlet.

Three way valve allows simple change over from normal to flushing mode.

Solid block carbon filter removes chlorine from fresh water supply, providing flush water without any negative affect on membrane. This also allows production of ultrapure water for battery filling,

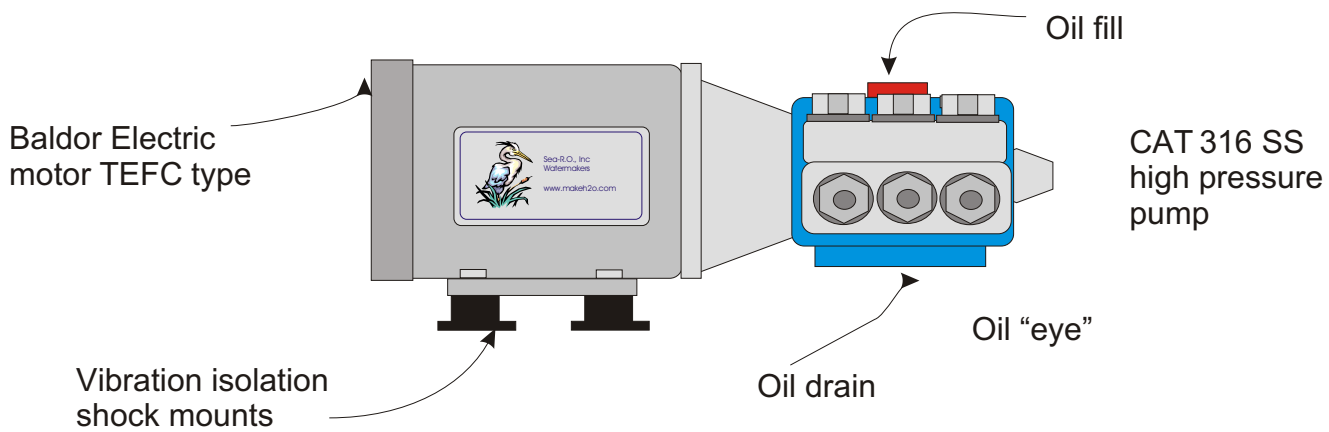

## High pressure pump and motor assembly

CAT 316 SS high pressure pump is a ceramic plunger design for long life and proven performance in seawater. CAT pumps are the longest lasting, most trouble free pumps available, service and parts distribution available worldwide and the simple design allows easy routine service without any special tools.

Pump has an oil filled crankcase with easy access to drain and fill. Unique oil "eye" allows oil level to be checked with a glance. No drips or dipsticks necessary.

Industry standard Baldor motor is the best, most efficient motor available. Service is almost never required, but if so, Baldor has an outstanding worldwide network of agents and service centers.

Pump and motor are smooth and quiet by design, and yet we go one step to further dampen any noise and vibration with flexible mounts. These also elevate the pump and motor to allow cleaning beneath the assembly.

Control panel provides total motor and pump protection from low voltage, low or high pressure, or improper operation.

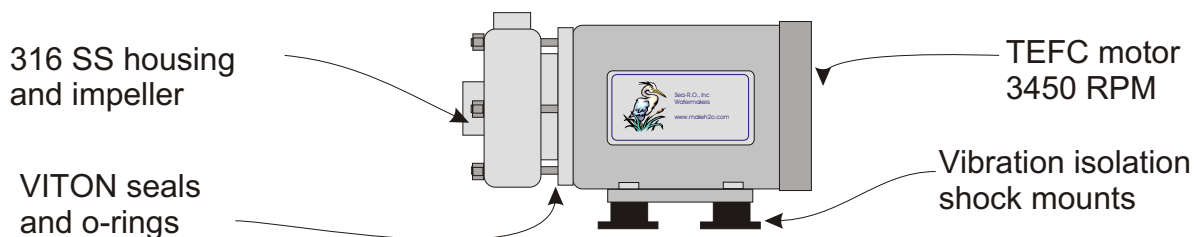

## Boost pump and motor assembly

316 SS investment cast pump is superior to plastic or stamped designs, and much safer for below waterline installation.

3450 RPM 1/2HP motor provides 15-20 psi of boost pressure for optimum filter life.

Vibration isolation mounts to eliminate noise and elevate assembly.

Pump is protected by control panel from dry running or low voltage

Sea-R.O., Inc. Tel: 954-527-5282, Fax: 954-462-7183, Mobile: 954-309-2775, [www.makeh2o.com](http://www.makeh2o.com)

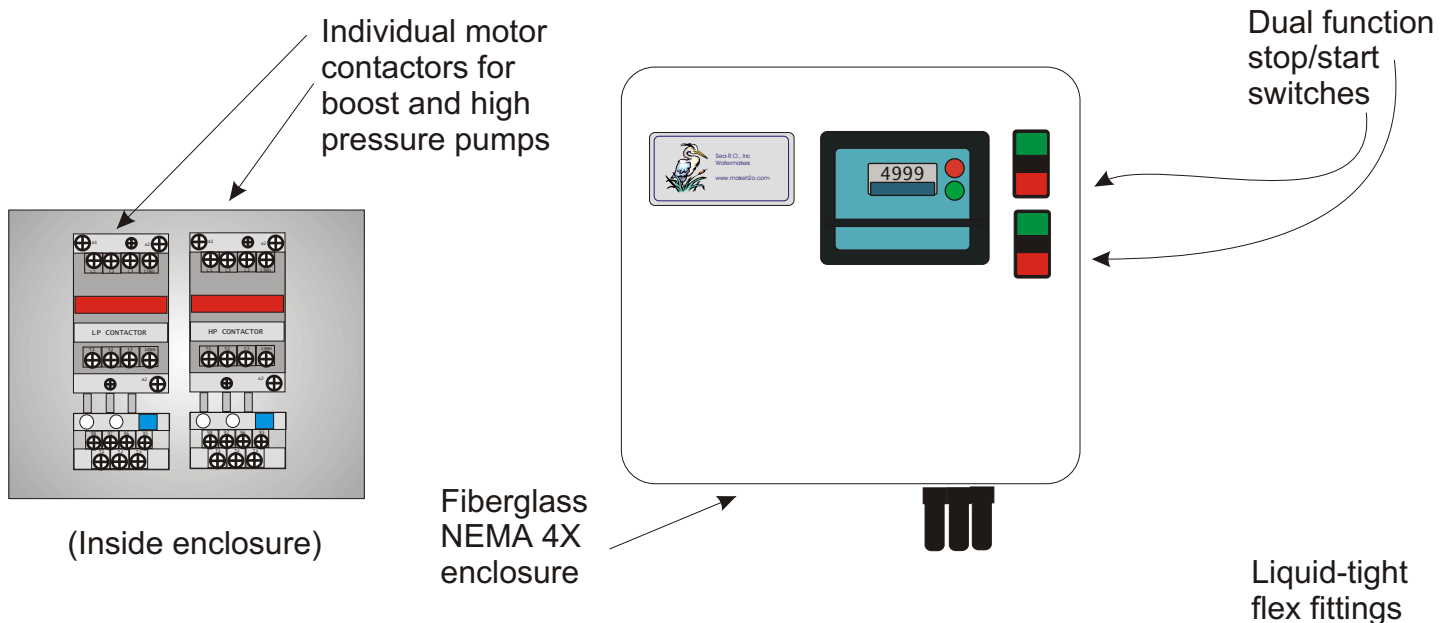

## “Nautilus” System Control Panel

System control panel provides complete operation and protection of all other system components. Rugged electrical components are housed inside a NEMA 4X rated enclosure which can tolerate splashing, washdowns, and the corrosive environment where watermakers are used.

Enclosure is designed for mounting with supplied flange which prevents any drilling or penetration into control panel.

Non-conductive enclosure prevents corrosion and provides operator safety.

Resettable overloads will shut system down if supply voltage is too low. This can occur on boat electrical systems, marinas, and islands.

Safety shut down switch for low pressure prevent any damage to components if the system is starved for water from a blocked inlet.

High pressure switch and back up relief valve protects system from any possible operator error.

Liquid-tight flex fittings are used on power supply, high pressure pump, and boost pump umbilical cables. These fittings prevent strain and chafe on cables where they enter control panel and motors.

10 foot leads are provided as standard. Longer lengths are available for an additional charge, or may be added in the field by installer. Multi-strand, tinned copper wire in round gray protective sheath (boat cable) is standard. High pressure pump and boost pump are pre-wired to control panel. You only need to connect the power supply.

Complete wiring diagram is provided for installation and operation.

Water Quality Monitor is factory preset to divert to drain any water that is produced that is over USEPA standards of 500 ppm TDS. A manual bypass valve is provided as well.